

Yorba Linda Community Center Yorba Room

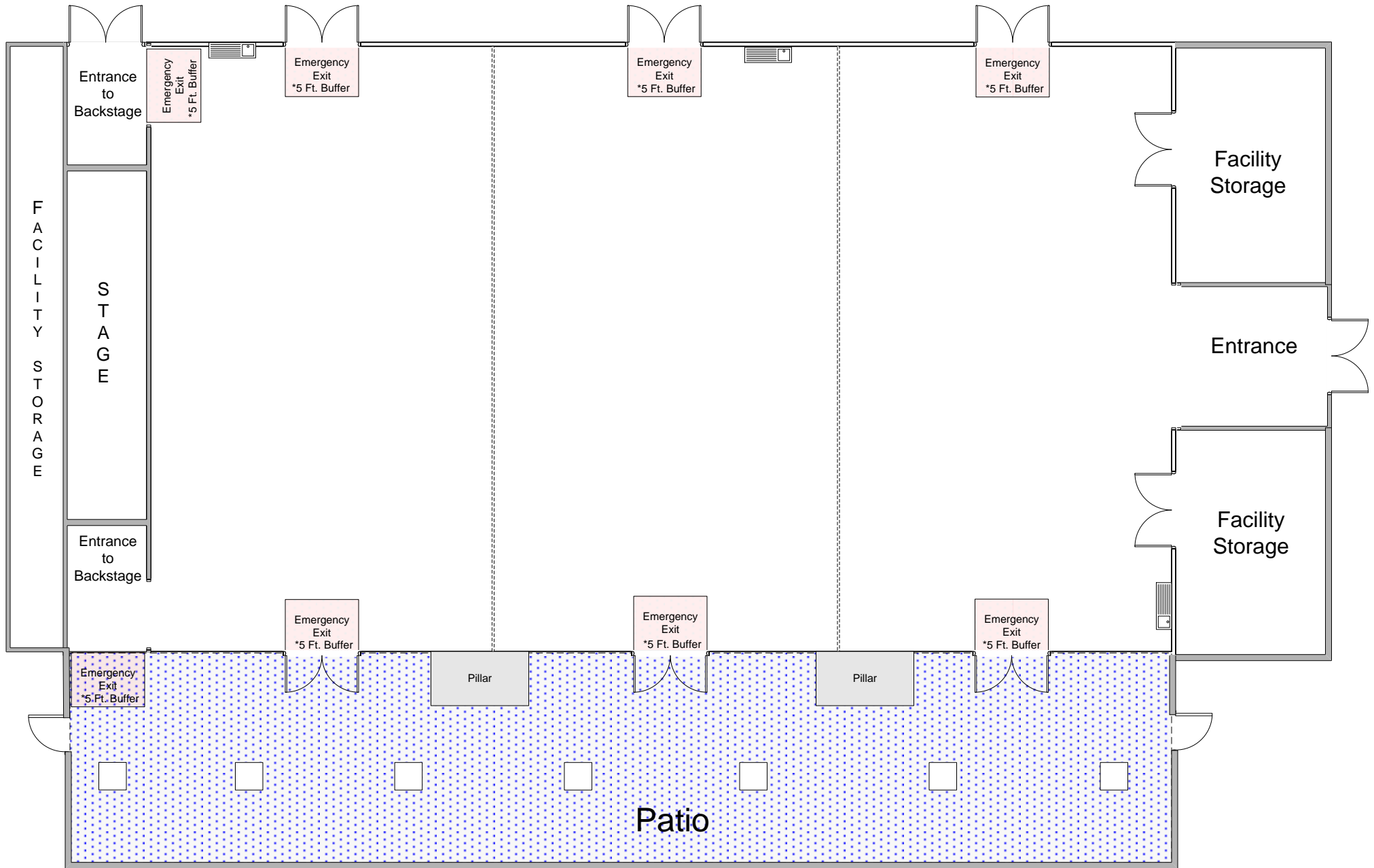

Applicant Name: _____
Event Date: _____
Received by/Date: _____

Email: eventrentals@yorba-linda.org
Website: www.ylccenter.com
Phone: 714-961-7181
Fax: 714-986-1025

**Yorba Linda Community Center
Yorba Room
(4018 sq. ft.)**

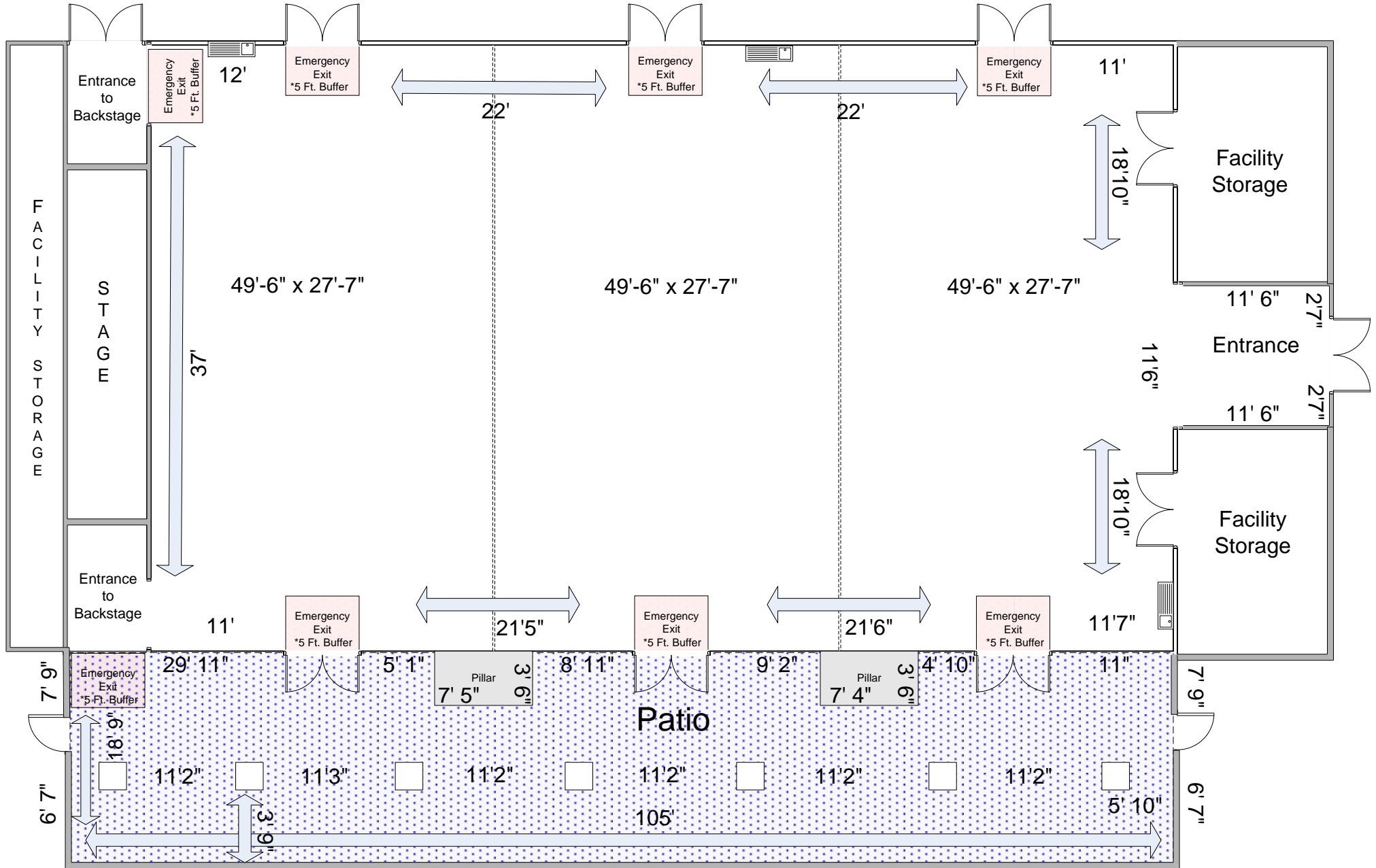

Applicant Name: _____
Event Date: _____
Received by/Date: _____

Email: eventrentals@yorba-linda.org
Website: www.ylccenter.com
Phone: 714-961-7181
Fax: 714-986-1025

**Yorba Linda Community Center
Yorba Room
Sports Banquet Seating for 304**

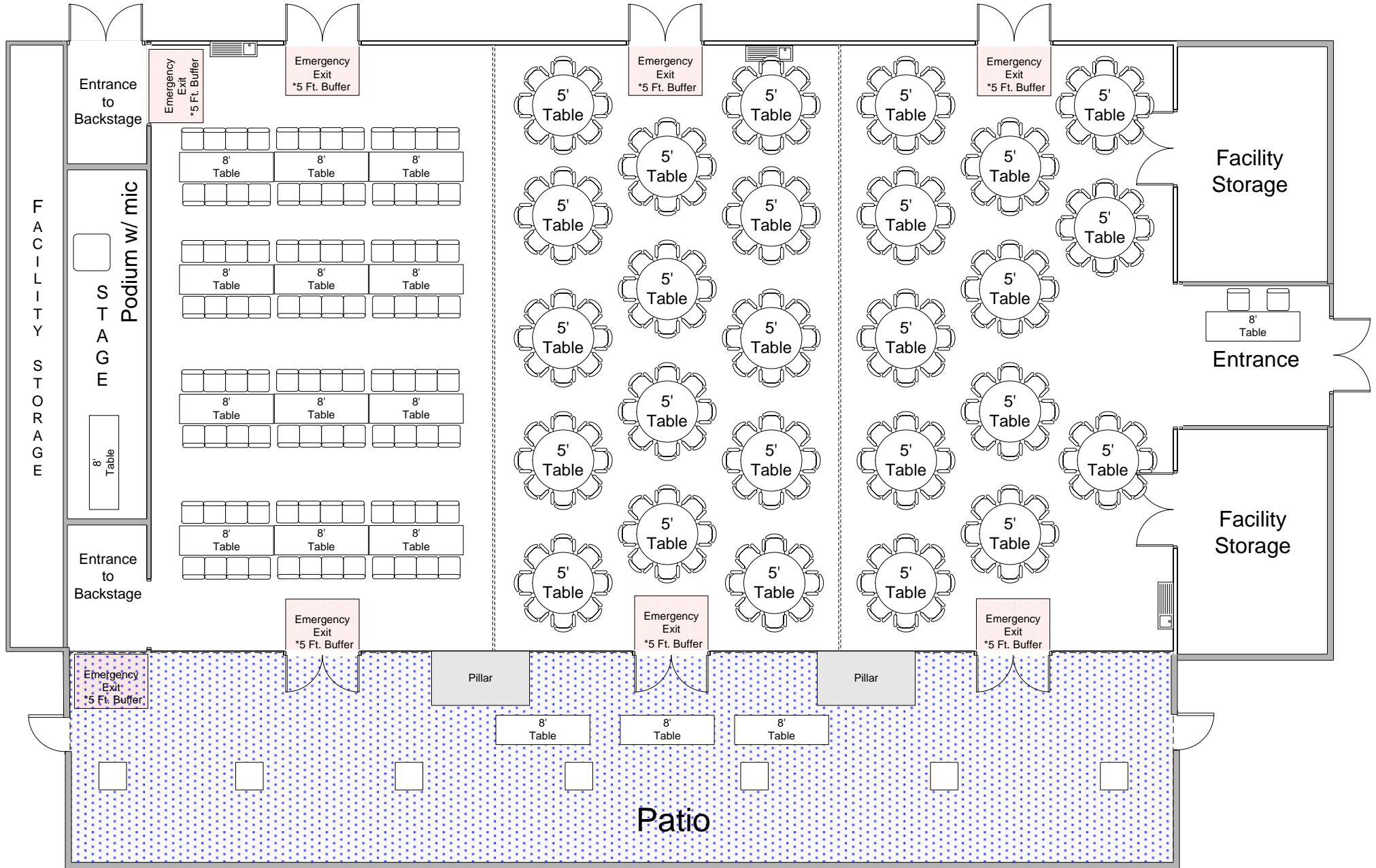

Applicant Name: _____
Event Date: _____
Received by/Date: _____

Email: eventrentals@yorba-linda.org
Website: www.ylccenter.com
Phone: 714-961-7181
Fax: 714-986-1025

Yorba Linda Community Center Yorba Room Banquet Seating for 304

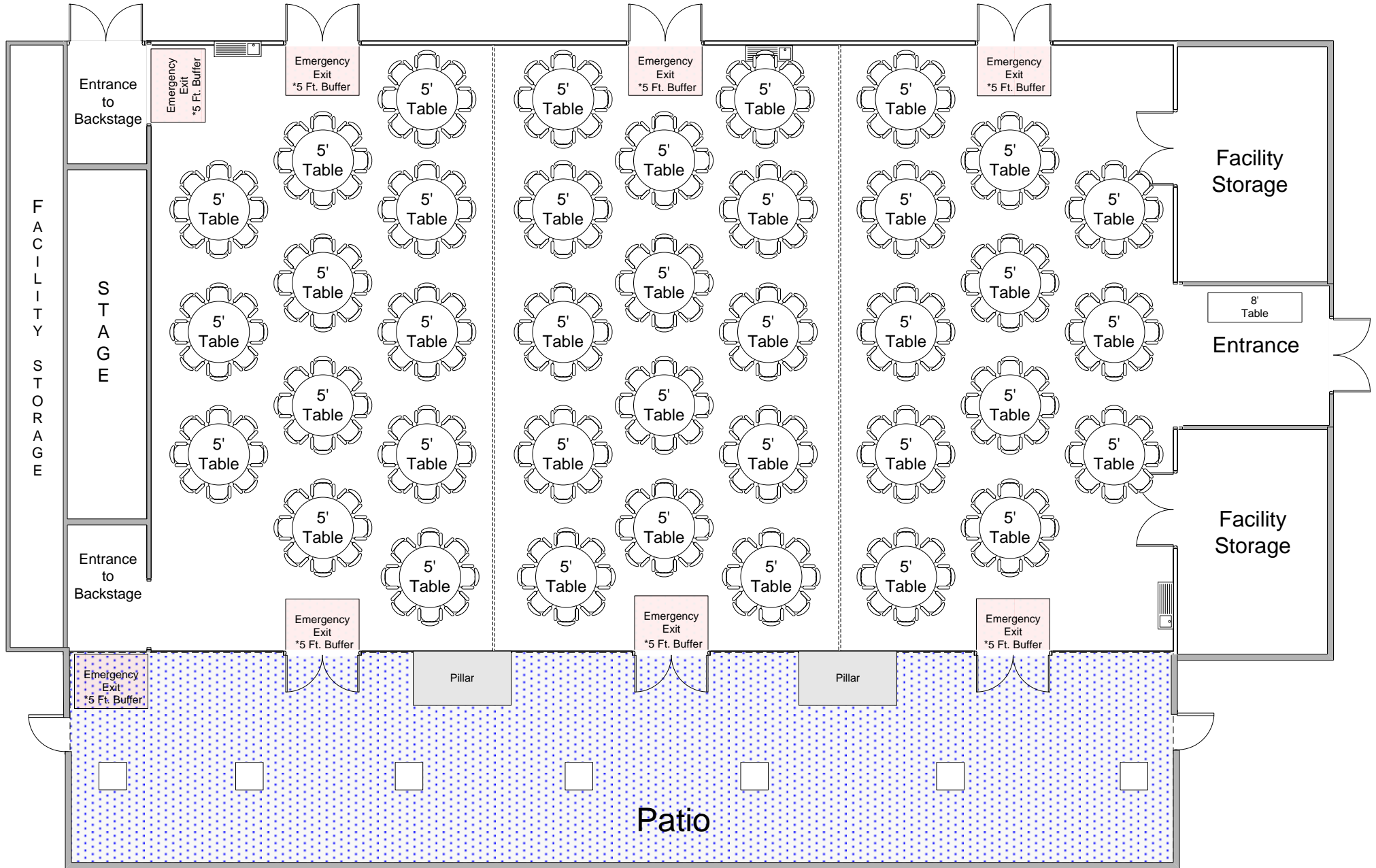

Applicant Name: _____
Event Date: _____
Received by/Date: _____

Email: eventrentals@yorba-linda.org
Website: www.ylccenter.com
Phone: 714-961-7181
Fax: 714-986-1025

Yorba Linda Community Center Yorba Room Banquet Seating for 224 with 8' Tables & Dance Floor

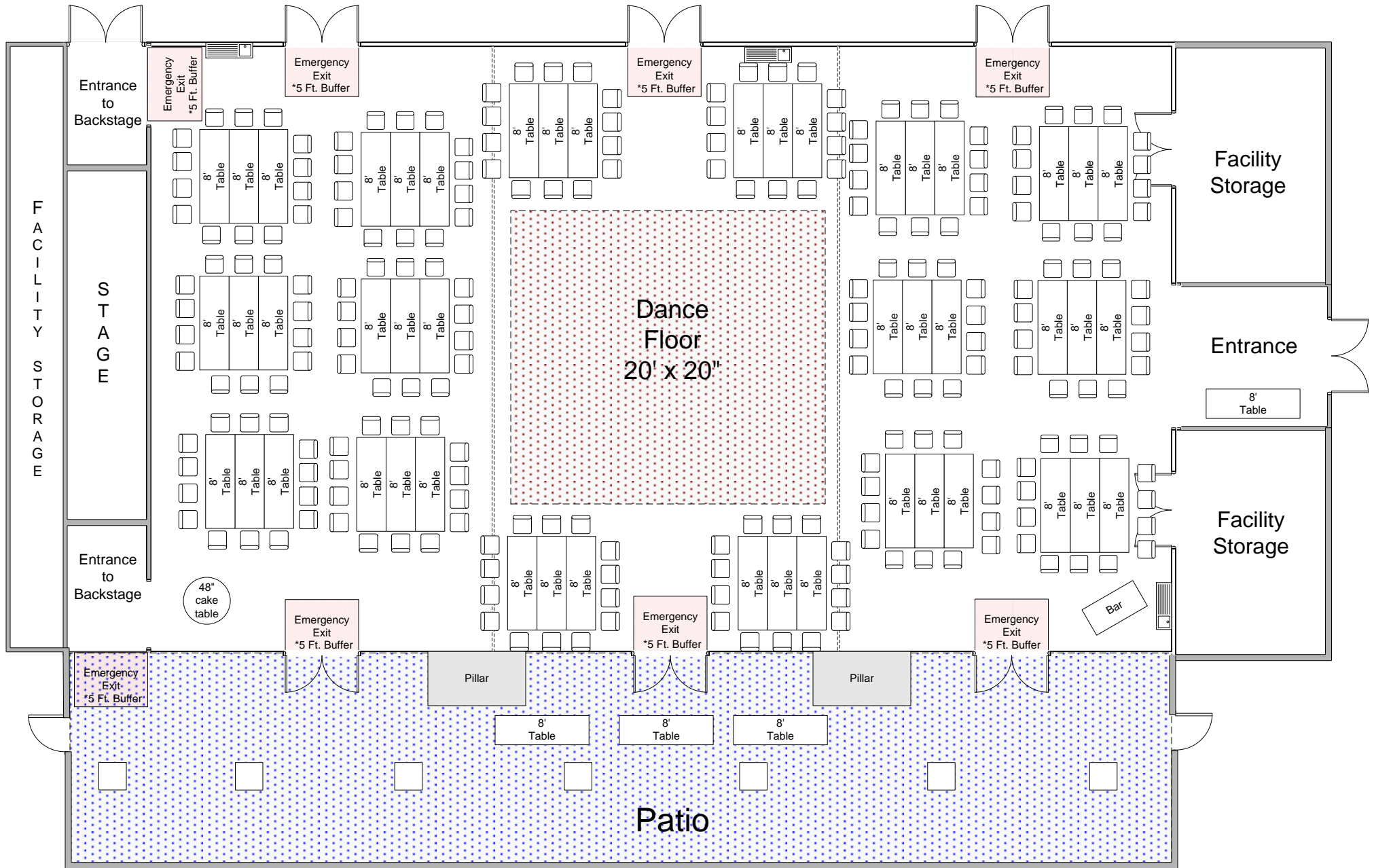

Applicant Name: _____
Event Date: _____
Received by/Date: _____

Email: eventrentals@yorba-linda.org
Website: www.ylccenter.com
Phone: 714-961-7181
Fax: 714-986-1025

Yorba Linda Community Center Yorba Room

Banquet Seating for 240 with 8' Tables & Dance Floor



Applicant Name: _____
Event Date: _____
Received by/Date: _____

Email: eventrentals@yorba-linda.org
Website: www.ylccenter.com
Phone: 714-961-7181
Fax: 714-986-1025

Yorba Linda Community Center Yorba Room Banquet Seating for 240 with Dance Floor

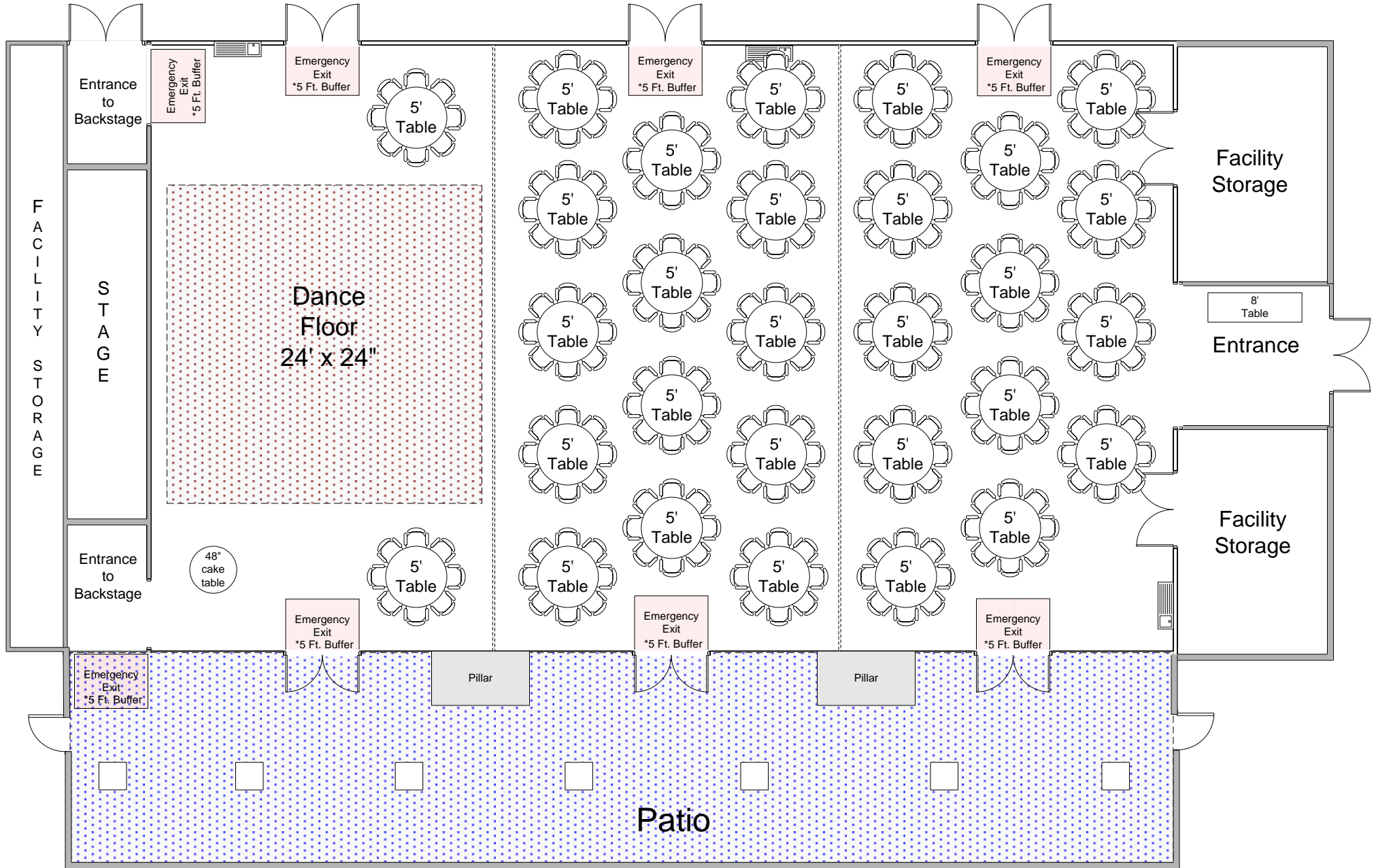

Applicant Name: _____
Event Date: _____
Received by/Date: _____

Email: eventrentals@yorba-linda.org
Website: www.ylccenter.com
Phone: 714-961-7181
Fax: 714-986-1025

Yorba Linda Community Center Yorba Room

Banquet Seating for 232 with Dance Floor & Head Table

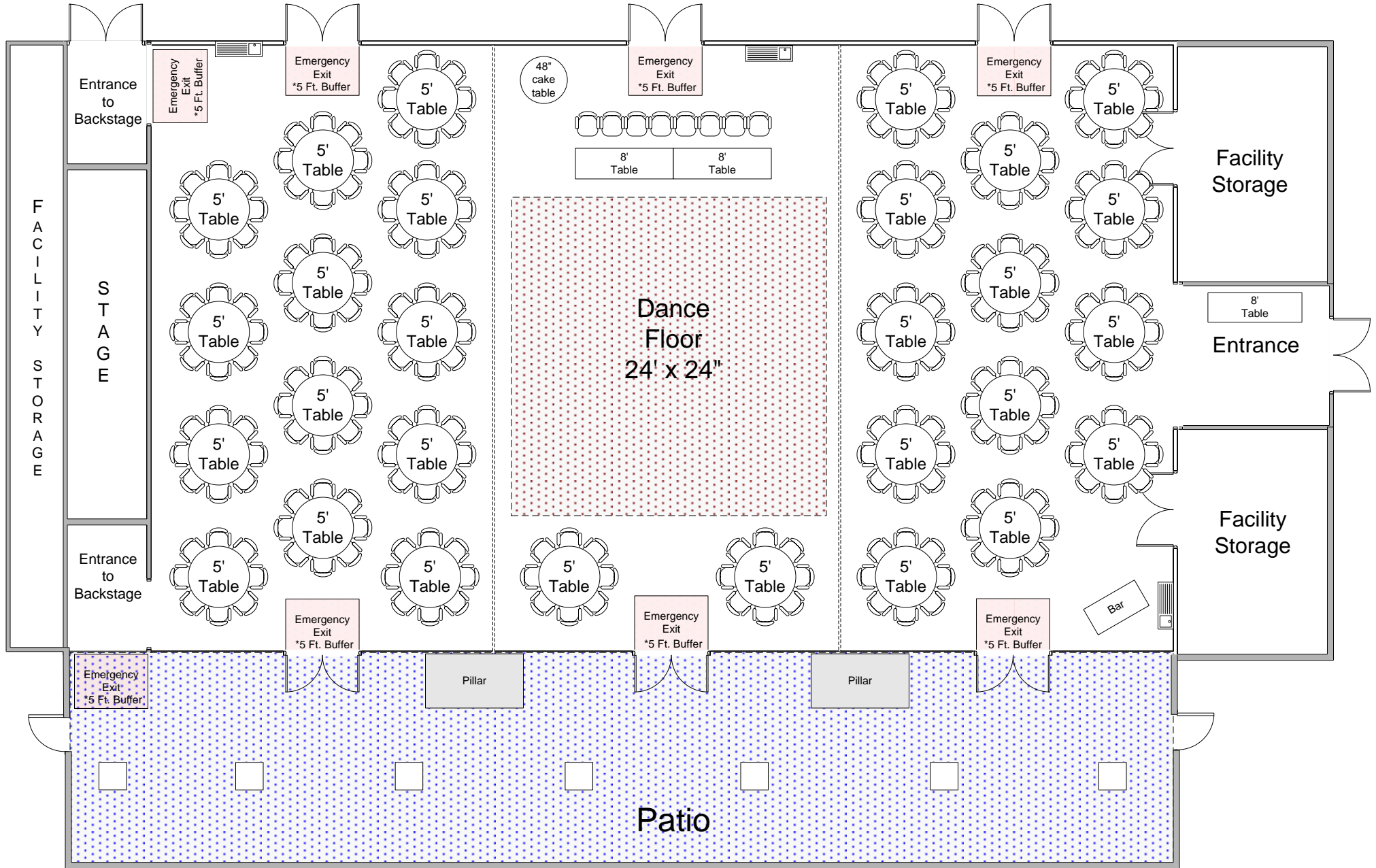

Applicant Name: _____
Event Date: _____
Received by/Date: _____

Email: eventrentals@yorba-linda.org
Website: www.ylccenter.com
Phone: 714-961-7181
Fax: 714-986-1025